







SUGGESTED LIGHT SOURCE		
	Halogen	Compact Fluorecent
ODILE S : ODILE M :	 1 x max 55W E27 HSG 1 x max 77W E27 HSG	 1 x max 24W E27 1 x max 24W E27
220/240V - 50-60Hz		

CERTIFICATION	
MADE IN ITALY	Certified production in Italy
	Class 2
	Fixture fitted for direct assembly on normally inflammable surfaces.
<b>IP20</b>	Protected against the entry of solid objects larger than 12mm. No protection against the ingress of water.
	Product conforms to European Directive Community
	Certification of conformity for the Euroasian Custom Union

**IT****AVVERTENZA**

La sicurezza dell'apparecchio é garantita all'osservanza di queste istruzioni pertanto si raccomanda di conservarle.  
Tutte le operazioni di montaggio, manutenzione e sostituzione lampadine, vanno eseguite assicurandosi che la rete di alimentazione sia disinserita.  
Non deve essere superata la potenza massima indicata.

**ATTENZIONE**

L'installazione deve essere effettuata da installatori qualificati in pieno rispetto della normativa.  
Se il cavo flessibile esterno di questo apparecchio viene danneggiato, deve essere sostituito esclusivamente dal costruttore, dal suo servizio di assistenza o da personale qualificato equivalente, al fine di evitare pericoli.

**EN****WARNING**

The safety of the fitting is guaranteed by the correct use of the following instructions. It is therefore necessary to keep them.  
When carrying out all assembly, maintenance and lamp replacement operations, make sure that the power is off.  
Do not exceed the maximum power indicated.

**ATTENTION**

The fitting should be installed by qualified installers to comply with the HD 384 standards. If the external flexible cable of this device is damaged, it has to be replaced only by the manufacturer, by its service assistance or by similar qualified personnel in order to avoid risks.

**FR****AVERTISSEMENT**

La sureté de l'appareil est garantie avec l'utilisation appropriée des instructions suivantes. Il est donc nécessaire de les garder.  
Toutes les opérations de montage, entretien et remplacement de l'ampoule ne doivent étre effectuées qu'après avoir coupé le courant.  
Il ne faut pas dépasser la puissance maximum indiquée.

**ATTENTION**

L'installation doit étre effectuée par des installateurs agréés, conformément à la norme HD 384.  
Si le câble extérieur flexible de cet appareil est endommagé, il doit étre remplacé exclusivement par le constructeur, son service d'assistance ou par du personnel équivalent qualifié, afin d'éviter tout danger.

**DE****SICHERHEITSHINWEISE**

Die Sicherheit des Gerates ist nur garantiert wenn die folgenden Vorschriften eingehalten werden. Es ist daher notwendig diese aufzubewahren.  
Montage, Wartung und Lampenwechsel dürfen nur nach Unterbrechung des Netz anschusses durchgeführt werden.  
Nie die höchste angegebene Leistung überschreiten.

**ACHTUNG**

Die Leuchte ist von qualifizierten Fachleuten im Einklang mit der Bestimmung HD 384 zu installieren.  
Wenn das externe flexible Kabel dieses Gerätes beschädigt ist, muss es nur durch den Hersteller, seinen Kundendienst oder einer ähnlich qualifizierten Person, um Gefahren zu vermeiden.



**IT** - Il simbolo riportato sull'apparecchio indica che il prodotto deve essere smaltito in modo differenziato dai rifiuti urbani.  
**EN** - The sign shown on the device indicates that the product must be thrown out in a different manner than with the urban trashes.  
**FR** - Le symbole montré sur l'appareil indique que le produit doit étre débarrassé de façon différente que les déchets urbains.  
**DE** - Das auf dem Gerät wiedergegebene Symbol zeigt an, dass das Produkt getrennt vom Städtüll entsorgt werden muss.

**ODILE**

Design Paolo Cappello, 2016

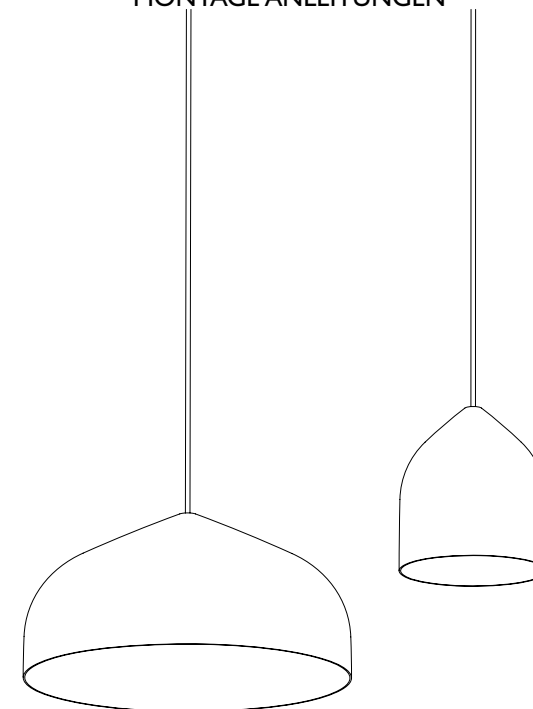
**ISTRUZIONI DI MONTAGGIO**  
**ASSEMBLY ISTRUCTIONS**  
**INSTRUCTIONS DE MONTAGE**  
**MONTAGE ANLEITUNGEN**

ODILE M

ODILE S

**LUMEN CENTER ITALIA S.r.l.**

Via Donatori del Sangue 37 20010, S. Stefano Ticino (Mi) Italy  
tel: +39.02.36544811 - fax: +39.02.36544818  
e-mail: info@lumencenteritalia.com - www.lumencenteritalia.com

LUMEN  
CENTER  
ITALIALIGHT  
CREATIVITY  
INNOVATION

- 1** **IT** Fissare la piastra (A) a soffitto, utilizzando tasselli ad espansione (B) idonei al tipo di superficie.  
**EN** Fix the plate (A) to the ceiling, using expansion plugs (B) suitable for the type of surface.  
**FR** Fixer la plaque (A) au plafond à l'aide des chevilles à expansion (B) approprié pour le type de surface.  
**DE** Befestigen Sie Die Platte (A) an der Decke mit entsprechenden geeigneten Dübel (B) für die Art der Oberfläche.

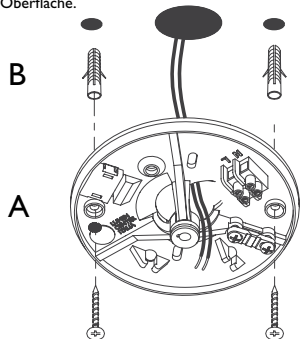

- 2** **IT** Far scorrere gli elementi (C) sul cavo di alimentazione (H) della lampada.  
**EN** Slide the element (C) on the power cord of the lamp (H).  
**FR** Faire defiler les elements (C) sur le câble d'alimentation (H) de la lampe.  
**DE** Gleiten Sie die Elemente (C) auf der Netzkabel (H) der Lampe.

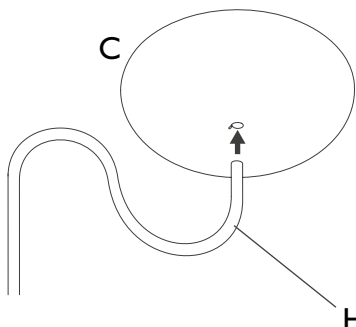

- 3** **IT** Far scorrere il cavo di alimentazione (H) all'interno della boccola posta sulla piastra (A) fino al raggiungimento dell'altezza desiderata.  
**EN** Slide the power cord (H) inside the bush placed on the plate (A) until the desired height is reached.  
**FR** Faire defiler le câble d'alimentation (H) à l'intérieur de la boucle mis sur la plaque (A) jusqu'à réalisation de l'atresse désirée.  
**DE** Gleiten Sie das Netzkabel (H) in der Hülse auf der Platte (A) bis das Erreichen der erforderlichen Höhe.

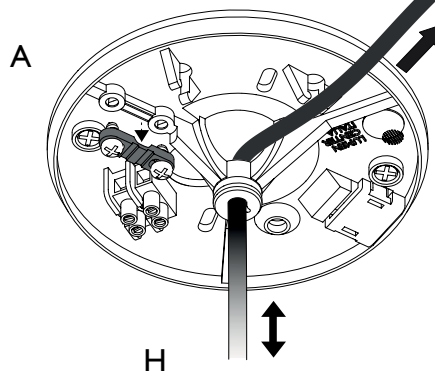

- 4** **IT** Bloccare il cavo di alimentazione utilizzando gli appositi supporti a scatto (I) posti sulla piastra (A) e fissare il morsetto bloccacavo (L).  
**EN** Fasten the power cable using the appropriate holders (I) placed on the plate (A) and secure the cable clamp (L).  
**FR** Blockieren Sie das Netzkabel mit der entsprechenden Eischnappshalterungen (I) auf der Platte (A) und sichern Sie den Klemmenkabel-Blockierung (L).  
**DE** Blockieren Sie das Netzkabel mit der entsprechenden Eischnappshalterungen (I) auf der Platte (A) und sichern Sie den Klemmenkabel-Blockierung (L).

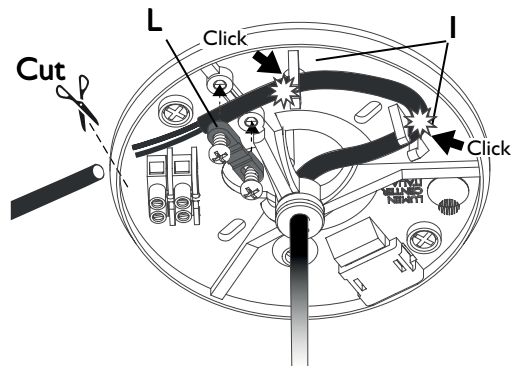

- 5** **IT** Se necessario tagliare il cavo di alimentazione in eccesso.  
**EN** If necessary, cut the power supply in excess.  
**FR** Si nécessaire couper le câble en excès.  
**DE** Wenn nötig, schneiden Sie das Netzkabel in rauhen Menge.

- 6** **IT** Effettuare i collegamenti elettrici con il morsetto (M) come mostrato in figura.  
**EN** Make the electrical connections to the terminal (M) as shown in the figure.  
**FR** Effectuer les liaisons électriques avec la borne (M) comme montré en illustration.  
**DE** Verbinden Sie die elektrische Anschlüsse an die Klemme (M) wie in Abbildung gezeigt.

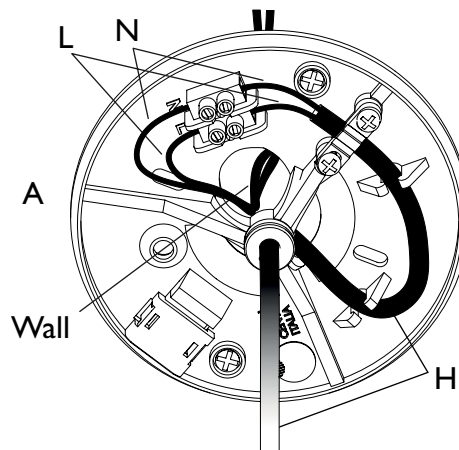

- 7** **IT** Chiudere il coperchio del rosone.  
**EN** Close the lid of the canopy.  
**FR** Fermer le couvercle de la rosace.  
**DE** Schließen Sie die Abdeckung der Rosette.

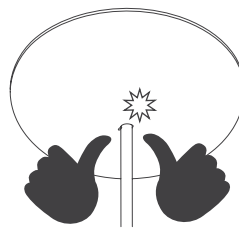

- 8** **IT** Inserire la lampadina (F) sulla struttura (E).  
**EN** Insert the bulb (F) on the structure (E).  
**FR** Insérer l'ampoule (F) sur la structure (E).  
**DE** Die Birne (F) einsetzen.

